



Soffioni doccia
Shower heads
Kopfbrausen
Douches de têtes
Rociadores de ducha
Лейки для душа
莲蓬头



Shower heads



Soffioni doccia
Shower heads
Kopfbrausen
Douches de têtes
Rociadores de ducha
Лейки для душа
莲蓬头

Gli articoli della collezione Soffioni doccia sono disponibili nelle famiglie di finiture sotto indicate:
The articles included in Shower heads collection are available in the following finishing families:
Die Artikel der Kollektion Kopfbrausen sind in den folgenden Ausführungsfamilien lieferbar:
Les articles de la collection Douches de têtes sont disponibles dans les familles finitions suivantes:
Los artículos de la colección Rociadores de ducha están disponibles en las familias de acabados que se indican a continuación:
Артикулы коллекции Лейки для душа имеются в указанных ниже семействах исполнения:
在莲蓬头系列里的产品备有下列的颜色种类:

Chrome
Chrome + Corian®
Black to White
Black to White + Corian®
Brushed
Matt Luxe
Matt Luxe + Corian®
Golden
Matt Golden
Matt Golden + Corian®



DATI TECNICI
TECHNICAL DATA
TECHNISCHE DATEN
DONNEES TECHNIQUES
DATOS TÉCNICOS
ТЕХНИЧЕСКИЕ ДАННЫЕ
技术数据

65° (max 80° C)

Temperatura ottimale acqua calda
Optimal hot water temperature
Optimaltemperatur vom warmen Wasser
Température optimale eau chaude
Temperatura óptima del agua caliente
Оптимальная температура горячей воды
最佳的热水温度

3 bar (min 1 - max 5)

Pressione ottimale di esercizio
Optimal operational pressure
Optimaler Betriebsdruck
Pression optimale de fonctionnement
Presión óptima de funcionamiento
Оптимальное рабочее давление
最佳工作压力

0,1 bar (max 1)

Differenza di pressione acqua calda/fredda
Hot/cold water pressure difference
Drucksunterschied vom warmen/kalten Wasser
Différence de pression eau chaude/froide
Diferencia de presión del agua caliente/fría
Разница давления холодной/горячей воды
冷/热水压力差

FIR ITALIA si riserva, ogni qualvolta si rendesse necessario, di apportare modifiche tecniche ed estetiche senza obbligo di preavviso. - FIR ITALIA, whenever necessary, reserves itself the right of deciding technical and aesthetic modifications without prior notice. - FIR ITALIA ist ausdrücklich dazu berechtigt, technische und ästhetische Änderungen an ihre einigen Produkte ohne vorherige Mitteilung vorzunehmen. FIR ITALIA se réserve le droit d'apporter des modifications techniques et esthétiques sans avis préalable. - FIR ITALIA se reserva el derecho, si lo considera necesario, de aportar modificaciones técnicas sin obligación de previo aviso. - FIR ITALIA оставляет за собой право во всех случаях, когда это будет необходимо, вносить технические и эстетические изменения без обязательства производить предварительное уведомление. - FIR ITALIA, 在必要时, 保留技术和外观修改的決定权, 恕不另行通知。

85.7240.8

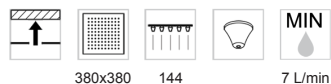
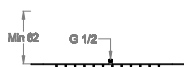
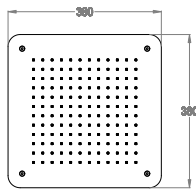

Articoli complementari necessari
Necessary complementary items
Notwendige komplementäre Artikel
Articles complémentaires nécessaires
Artículos complementarios necesarios
Необходимые дополнительные предметы
必须的配套产品

05.2449.2



page 498

- Parte esterna soffione doccia incasso a soffitto 380x380 mm in acciaio inox.
- External part for built-in ceiling-mounted stainless steel shower head 380x380 mm.
- Fertigmontageset zu UP-Regenbrause zur Deckenmontage, 380x380 mm aus Edelstahl.
- Partie extérieure pour plafond douche encastrée 380x380 mm, en acier inox.
- Parte externa rociador de ducha empotrable para montaje al techo 380x380 mm de acero inoxidable.
- Наружная часть для монтируемой на потолке, встроенной насадки душа из нержавеющей стали 380x380 мм.
- 吊顶嵌入式不锈钢莲蓬头 380x380 mm 的外露部分。

Chrome

Black to White

Brushed

Matt Luxe

Matt Golden

85.7245.8

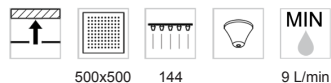
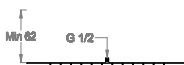
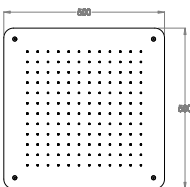

Articoli complementari necessari
Necessary complementary items
Notwendige komplementäre Artikel
Articles complémentaires nécessaires
Artículos complementarios necesarios
Необходимые дополнительные предметы
必须的配套产品

05.2449.3



page 498

- Parte esterna soffione doccia incasso a soffitto 500x500 mm in acciaio inox.
- External part for built-in ceiling-mounted stainless steel shower head 500x500 mm.
- Fertigmontageset zu UP-Regenbrause zur Deckenmontage 500x500 mm aus Edelstahl.
- Partie extérieure pour plafond douche encastrée 500x500 mm, en acier inox.
- Parte externa rociador de ducha empotrable para montaje al techo 500x500 mm de acero inoxidable.
- Наружная часть для монтируемой на потолке, встроенной насадки душа из нержавеющей стали 500x500 мм.
- 吊顶嵌入式不锈钢莲蓬头 500x500 mm 的外露部分。

Chrome

Black to White

Brushed

Matt Luxe

Matt Golden

Natural Colour

- Parte incasso soffione doccia incasso a soffitto.
- Built-in part for ceiling-mounted shower head.
- UP-Einbaukörper zu UP-Regenbrause zur Deckenmontage.
- Partie encastrée pour plafond douche encastrée.
- Parte empotrable rociador de ducha empotrable para montaje al techo.
- Встроенная часть для монтируемой на потолке, встроенной насадки душа.
- 吊顶嵌入式莲蓬头的预埋件。

84.7216.8

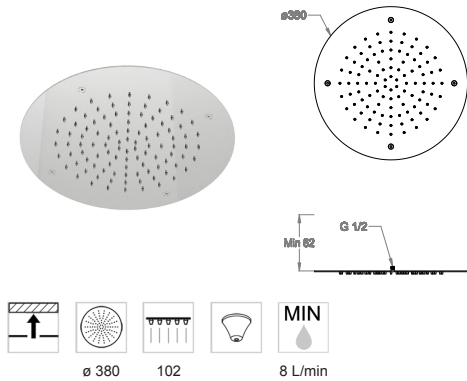

Articoli complementari necessari
 Necessary complementary items
 Notwendige komplementäre Artikel
 Articles complémentaires nécessaires
 Artículos complementarios necesarios
 Необходимые дополнительные предметы
 必须的配套产品

05.2449.4



page 498

- Parte esterna soffione doccia incasso a soffitto \varnothing 380 mm in acciaio inox.
- External part for built-in ceiling-mounted stainless steel shower head \varnothing 380 mm.
- Fertigmontageset zu UP-Regenbrause zur Deckenmontage \varnothing 380 mm aus Edelstahl.
- Partie extérieure pour plafond douche \varnothing 380 mm, encastrée, en acier inox.
- Parte externa rociador de ducha empotrable para montaje al techo \varnothing 380 mm de acero inoxidable.
- Наружная часть для монтируемой на потолке, встроенной насадки душа из нержавеющей стали \varnothing 380 мм.
- 吊顶嵌入式不锈钢莲蓬头 \varnothing 380 mm的外露部分。

Chrome

Black to White

Brushed

Matt Luxe

Matt Golden

84.7219.8

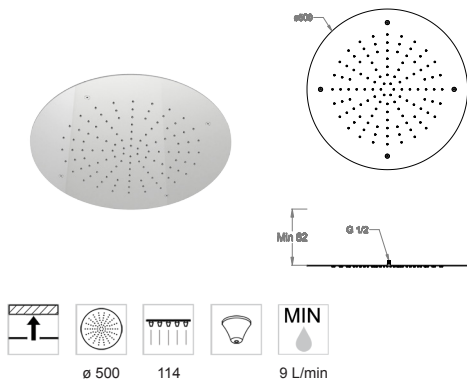

Articoli complementari necessari
 Necessary complementary items
 Notwendige komplementäre Artikel
 Articles complémentaires nécessaires
 Artículos complementarios necesarios
 Необходимые дополнительные предметы
 必须的配套产品

05.2449.5



page 499

- Parte esterna soffione doccia incasso a soffitto \varnothing 500 mm in acciaio inox.
- External part for built-in ceiling-mounted stainless steel shower head \varnothing 500 mm.
- Fertigmontageset zu UP-Regenbrause zur Deckenmontage \varnothing 500 mm aus Edelstahl.
- Partie extérieure pour plafond douche encastrée \varnothing 500 mm, en acier inox.
- Parte externa rociador de ducha empotrable para montaje al techo \varnothing 500 mm de acero inoxidable.
- Наружная часть для монтируемой на потолке, встроенной насадки душа из нержавеющей стали \varnothing 500 мм.
- 吊顶嵌入式不锈钢莲蓬头 \varnothing 500 mm的外露部分。

Chrome

Black to White

Brushed

Matt Luxe

Matt Golden

Natural Colour

93.7094.4

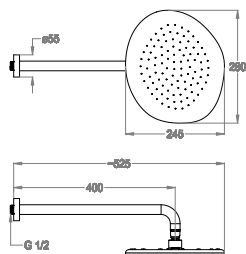

- Soffione doccia a parete 280x245 mm.
- Wall-mounted shower head 280x245 mm.
- Kopfbrause zur Wandmontage 280x245 mm.
- Douche de tête murale 280x245 mm.
- Rociador mural 280x245 mm.
- Настенная душевая лейка 280x245 мм.
- 壁装式莲蓬头 280x245 mm。

Chrome

Black to White

Matt Luxe

Matt Golden

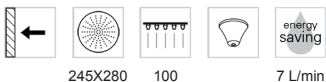

93.7096.4

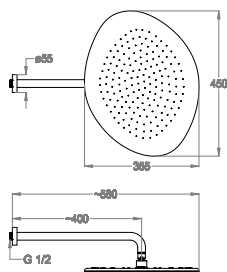

- Soffione doccia a parete 450x355 mm.
- Wall-mounted shower head 450x355 mm.
- Kopfbrause zur Wandmontage 450x355 mm.
- Douche de tête murale 450x355 mm.
- Rociador mural 450x355 mm.
- Настенная душевая лейка 450x355 мм.
- 壁装式莲蓬头 450x355 mm。

Chrome

Black to White

Matt Luxe

Matt Golden

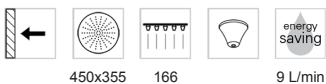

93.7093.4

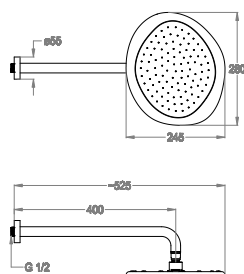

- Soffione doccia a parete 280x245 mm.
- Wall-mounted shower head 280x245 mm.
- Kopfbrause zur Wandmontage 280x245 mm.
- Douche de tête murale 280x245 mm.
- Rociador mural 280x245 mm.
- Настенная душевая лейка 280x245 мм.
- 壁装式莲蓬头 280x245 mm。

Chrome + Corian®

Black to White + Corian®

Matt Luxe + Corian®

Matt Golden + Corian®

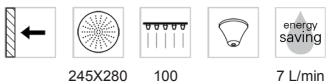

93.7095.4

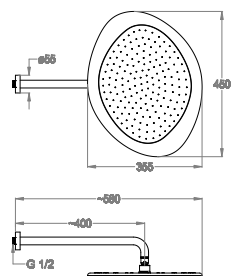

- Soffione doccia a parete 450x355 mm.
- Wall-mounted shower head 450x355 mm.
- Kopfbrause zur Wandmontage 450x355 mm.
- Douche de tête murale 450x355 mm.
- Rociador mural 450x355 mm.
- Настенная душевая лейка 450x355 мм.
- 壁装式莲蓬头 450x355 mm。

Chrome + Corian®

Black to White + Corian®

Matt Luxe + Corian®

Matt Golden + Corian®

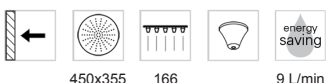

93.7094.6

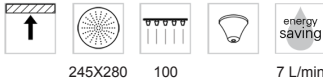
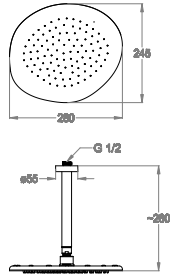

245X280 100 7 L/min

- Soffione doccia a soffitto 280x245 mm, h. 260 mm.
- Ceiling-mounted shower head 280x245 mm, 260 mm high.
- Kopfbrause zur Deckenmontage 280x245 mm, Höhe 260 mm.
- Douche de tête à plafond 280x245 mm, hauteur 260 mm.
- Rociador de techo 280x245 mm, altura 260 mm.
- Потолочная душевая лейка 280x245 мм, высотой 260 мм.
- 吊顶式莲蓬头 280x245 mm, 260 mm高。

Chrome

Black to White

Matt Luxe

Matt Golden

93.7094.8

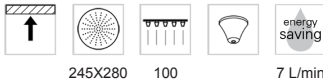
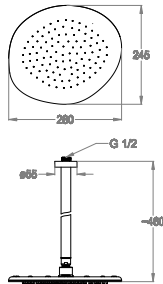

245X280 100 7 L/min

- Soffione doccia a soffitto 280x245 mm, h. 460 mm.
- Ceiling-mounted shower head 280x245 mm, 460 mm high.
- Kopfbrause zur Deckenmontage 280x245 mm, Höhe 460 mm.
- Douche de tête à plafond 280x245 mm, hauteur 460 mm.
- Rociador de techo 280x245 mm, altura 460 mm.
- Потолочная душевая лейка 280x245 мм, высотой 460 мм.
- 吊顶式莲蓬头 280x245 mm, 460 mm高。

Chrome

Black to White

Matt Luxe

Matt Golden

93.7096.6

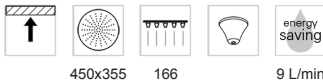
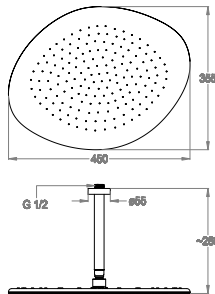

450x355 166 9 L/min

- Soffione doccia a soffitto 450x355 mm, h. 260 mm.
- Ceiling-mounted shower head 450x355 mm, 260 mm high.
- Kopfbrause zur Deckenmontage 450x355 mm, Höhe 260 mm.
- Douche de tête à plafond 450x355 mm, hauteur 260 mm.
- Rociador de techo 450x355 mm, altura 260 mm.
- Потолочная душевая лейка 450x355 мм, высотой 260 мм.
- 吊顶式莲蓬头 450x355 mm, 260 mm高。

Chrome

Black to White

Matt Luxe

Matt Golden

93.7096.8

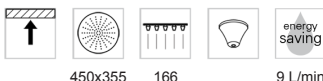
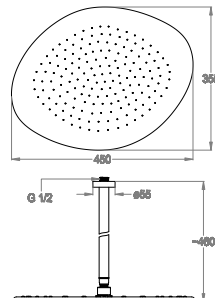

450x355 166 9 L/min

- Soffione doccia a soffitto 450x355 mm, h. 460 mm.
- Ceiling-mounted shower head 450x355 mm, 460 mm high.
- Kopfbrause zur Deckenmontage 450x355 mm, Höhe 460 mm.
- Douche de tête à plafond 450x355 mm, hauteur 460 mm.
- Rociador de techo 450x355 mm, altura 460 mm.
- Потолочная душевая лейка 450x355 мм, высотой 460 мм.
- 吊顶式莲蓬头 450x355 mm, 460 mm高。

Chrome

Black to White

Matt Luxe

Matt Golden

93.7093.6

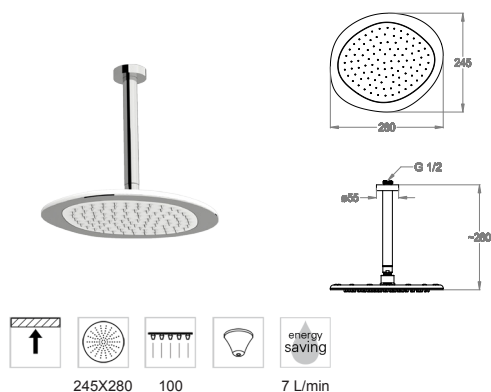

- Soffione doccia a soffitto 280x245 mm, h. 260 mm.
- Ceiling-mounted shower head 280x245 mm, 260 mm high.
- Kopfbrause zur Deckenmontage 280x245 mm, Höhe 260 mm.
- Douche de tête à plafond 280x245 mm, hauteur 260 mm.
- Rociador de techo 280x245 mm, altura 260 mm.
- Потолочная душевая лейка 280x245 мм, высотой 260 мм.
- 吊顶式莲蓬头 280x245 mm , 260 mm高。

Chrome + Corian®

Black to White + Corian®

Matt Luxe + Corian®

Matt Golden + Corian®

93.7093.8

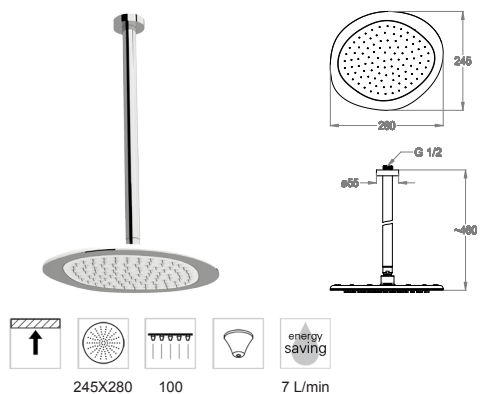

- Soffione doccia a soffitto 280x245 mm, h. 460 mm.
- Ceiling-mounted shower head 280x245 mm, 460 mm high.
- Kopfbrause zur Deckenmontage 280x245 mm, Höhe 460 mm.
- Douche de tête à plafond 280x245 mm, hauteur 460 mm.
- Rociador de techo 280x245 mm, altura 460 mm.
- Потолочная душевая лейка 280x245 мм, высотой 460 мм.
- 吊顶式莲蓬头 280x245 mm , 460 mm高。

Chrome + Corian®

Black to White + Corian®

Matt Luxe + Corian®

Matt Golden + Corian®

93.7095.6

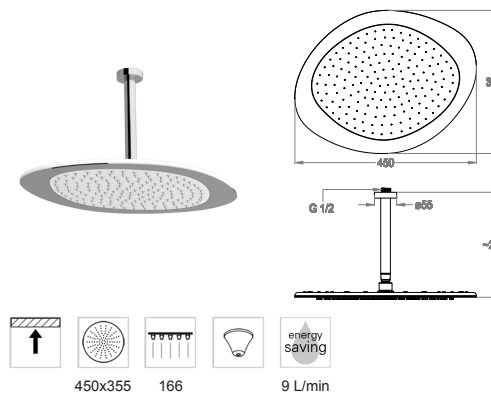

- Soffione doccia a soffitto 450x355 mm, h. 260 mm.
- Ceiling-mounted shower head 450x355 mm, 260 mm high.
- Kopfbrause zur Deckenmontage 450x355 mm, Höhe 260 mm.
- Douche de tête à plafond 450x355 mm, hauteur 260 mm.
- Rociador de techo 450x355 mm, altura 260 mm.
- Потолочная душевая лейка 450x355 мм, высотой 260 мм.
- 吊顶式莲蓬头 450x355 mm , 260 mm高。

Chrome + Corian®

Black to White + Corian®

Matt Luxe + Corian®

Matt Golden + Corian®

93.7095.8

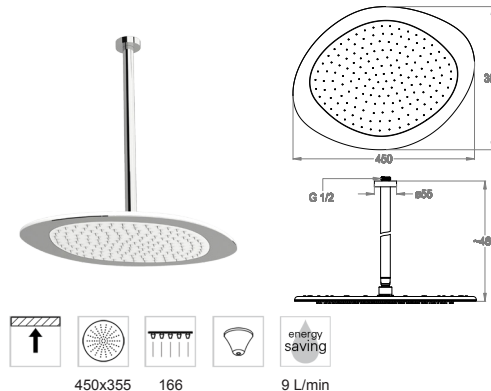

- Soffione doccia a soffitto 450x355 mm, h. 460 mm.
- Ceiling-mounted shower head 450x355 mm, 460 mm high.
- Kopfbrause zur Deckenmontage 450x355 mm, Höhe 460 mm.
- Douche de tête à plafond 450x355 mm, hauteur 460 mm.
- Rociador de techo 450x355 mm, altura 460 mm.
- Потолочная душевая лейка 450x355 мм, высотой 460 мм.
- 吊顶式莲蓬头 450x355 mm , 460 mm高。

Chrome + Corian®

Black to White + Corian®

Matt Luxe + Corian®

Matt Golden + Corian®

05.5422.8 NEW

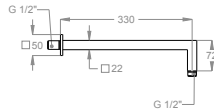

- Braccio doccia a parete, lunghezza 330 mm.
- Wall-mounted shower arm, 330 mm long.
- Brausearm zur Wandmontage, Länge 330 mm.
- Bras de douche mural, longueur 330 mm.
- Brazo ducha mural, longitud 330 mm.
- Настенный рычаг для душа, длина 330 мм.
- 壁装式淋浴吊臂，330 mm长。

Chrome

Black to White

Brushed

Matt Luxe

Matt Golden



05.5424.8 NEW

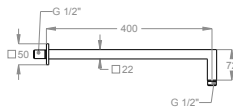

- Braccio doccia a parete, lunghezza 400 mm.
- Wall-mounted shower arm, 400 mm long.
- Brausearm zur Wandmontage, Länge 400 mm.
- Bras de douche mural, longueur 400 mm.
- Brazo ducha mural, longitud 400 mm.
- Настенный рычаг для душа, длина 400 мм.
- 壁装式淋浴吊臂，400 mm长。

Chrome

Black to White

Brushed

Matt Luxe

Matt Golden



05.5414.2

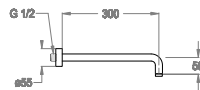

- Braccio doccia a parete, lunghezza 300 mm.
- Wall-mounted shower arm, 300 mm long.
- Brausearm zur Wandmontage, Länge 300 mm.
- Bras de douche mural, longueur 300 mm.
- Brazo ducha mural, longitud 300 mm.
- Настенный рычаг для душа, длина 300 мм.
- 壁装式淋浴吊臂，300 mm长。

Chrome

Black to White

Brushed

Matt Luxe

Golden

Matt Golden



05.5414.1

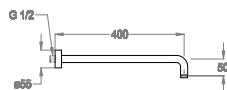

- Braccio doccia a parete, lunghezza 400 mm.
- Wall-mounted shower arm, 400 mm long.
- Brausearm zur Wandmontage, Länge 400 mm.
- Bras de douche mural, longueur 400 mm.
- Brazo ducha mural, longitud 400 mm.
- Настенный рычаг для душа, длина 400 мм.
- 壁装式淋浴吊臂，400 mm长。

Chrome

Black to White

Brushed

Matt Luxe

Golden

Matt Golden



05.5424.0

- Braccio doccia a parete, lunghezza 300 mm.
- Wall-mounted shower arm, 300 mm long.
- Brausearm zur Wandmontage, Länge 300 mm.
- Bras de douche mural, longueur 300 mm.
- Brazo ducha mural, longitud 300 mm.
- Настенный рычаг для душа, длина 300 мм.
- 壁装式淋浴吊臂，300 mm长。

Chrome

Black to White

Brushed

Matt Luxe

Matt Golden

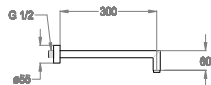

05.5424.1

- Braccio doccia a parete, lunghezza 400 mm.
- Wall-mounted shower arm, 400 mm long.
- Brausearm zur Wandmontage, Länge 400 mm.
- Bras de douche mural, longueur 400 mm.
- Brazo ducha mural, longitud 400 mm.
- Настенный рычаг для душа, длина 400 мм.
- 壁装式淋浴吊臂，400 mm长。

Chrome

Black to White

Brushed

Matt Luxe

Matt Golden



05.5444.0

- Braccio doccia a parete, posizionabile, lunghezza 350 mm.
- Wall-mounted, adaptable shower arm, 350 mm long.
- Brausearm zur Wandmontage, frei positionierbar, Länge 350 mm.
- Bras de douche mural réglable, longueur 350 mm.
- Brazo ducha mural, de posición regulable, longitud 350 mm.
- Настенный рычаг для душа, с изменяемым положением, длина 350 мм.
- 壁装式可调淋浴吊臂，350 mm长。

Chrome

Black to White

Brushed

Matt Luxe

Golden

Matt Golden

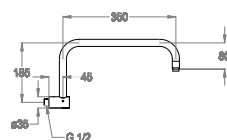

05.5454.0

- Braccio doccia a parete, posizionabile, lunghezza 350 mm.
- Wall-mounted, adaptable shower arm, 350 mm long.
- Brausearm zur Wandmontage, frei positionierbar, Länge 350 mm.
- Bras de douche mural réglable, longueur 350 mm.
- Brazo ducha mural, de posición regulable, longitud 350 mm.
- Настенный рычаг для душа, с изменяемым положением, длина 350 мм.
- 壁装式可调淋浴吊臂，350 mm长。

Chrome

Black to White

Brushed

Matt Luxe

Matt Golden

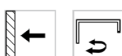
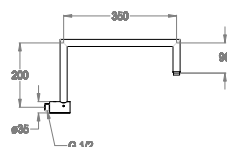

05.5434.0

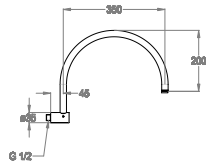

- Braccio doccia a parete, posizionabile, lunghezza 350 mm.
- Wall-mounted, adaptable shower arm, 350 mm long.
- Brausearm zur Wandmontage, frei positionierbar, Länge 350 mm.
- Bras de douche mural réglable, longueur 350 mm.
- Brazo ducha mural, de posición regulable, longitud 350 mm.
- Настенный рычаг для душа, с изменяемым положением, длина 350 мм.
- 壁装式可调淋浴吊臂, 350 mm长。

Chrome

Black to White

Brushed

Matt Luxe

Golden

Matt Golden

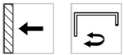

05.5404.1 NEW

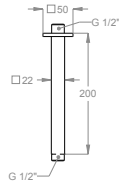

- Braccio doccia a soffitto, h. 200 mm.
- Ceiling-mounted shower arm, 200 mm high.
- Brausearm zur Deckenmontage, Höhe 200 mm.
- Bras de douche au plafond, hauteur 200 mm.
- Brazo ducha de techo, altura 200 mm.
- Потолочный рычаг для душа, высотой 200 мм.
- 吊顶式淋浴吊臂, 200 mm高。

Chrome

Black to White

Brushed

Matt Luxe

Matt Golden



05.5403.1

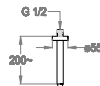

- Braccio doccia a soffitto, h. 200 mm.
- Ceiling-mounted shower arm, 200 mm high.
- Brausearm zur Deckenmontage, Höhe 200 mm.
- Bras de douche au plafond, hauteur 200 mm.
- Brazo ducha de techo, altura 200 mm.
- Потолочный рычаг для душа, высотой 200 мм.
- 吊顶式淋浴吊臂, 200 mm高。

Chrome

Black to White

Brushed

Matt Luxe

Golden

Matt Golden



05.5407.1

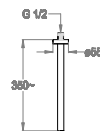

- Braccio doccia a soffitto, h. 350 mm.
- Ceiling-mounted shower arm, 350 mm high.
- Brausearm zur Deckenmontage, Höhe 350 mm.
- Bras de douche au plafond, hauteur 350 mm.
- Brazo ducha de techo, altura 350 mm.
- Потолочный рычаг для душа, высотой 350 мм.
- 吊顶式淋浴吊臂, 350 mm高。

Chrome

Black to White

Brushed

Matt Luxe

Golden

Matt Golden



04.2333.0

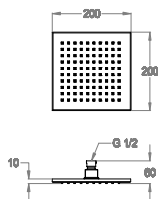

- Soffione doccia 200x200 mm.
- Shower head 200x200 mm.
- Kopfbrause 200x200 mm.
- Douche de tête 200x200 mm.
- Rociador 200x200 mm.
- Душевая лейка 200x200 мм.
- 莲蓬头 200x200 mm。

Chrome

Black to White

Brushed

Matt Luxe

Matt Golden



200x200 100 6 L/min 22 L/min

04.2337.0

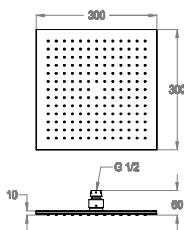

- Soffione doccia 300x300 mm.
- Shower head 300x300 mm.
- Kopfbrause 300x300 mm.
- Douche de tête 300x300 mm.
- Rociador 300x300 mm.
- Душевая лейка 300x300 мм.
- 莲蓬头 300x300 mm。

Chrome

Black to White

Brushed

Matt Luxe

Matt Golden



300x300 169 8 L/min 24 L/min

04.2310.0

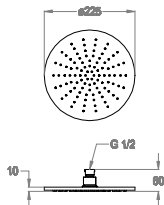

- Soffione doccia Ø 225 mm.
- Shower head Ø 225 mm.
- Kopfbrause Ø 225 mm.
- Douche de tête Ø 225 mm.
- Rociador Ø 225 mm.
- Душевая лейка Ø 225 мм.
- 莲蓬头 Ø 225 mm。

Chrome

Black to White

Brushed

Matt Luxe

Matt Golden



Ø 225 102 6 L/min 22 L/min

04.2312.0

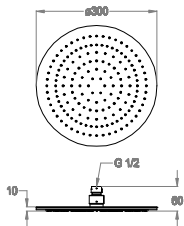

- Soffione doccia Ø 300 mm.
- Shower head Ø 300 mm.
- Kopfbrause Ø 300 mm.
- Douche de tête Ø 300 mm.
- Rociador Ø 300 mm.
- Душевая лейка Ø 300 мм.
- 莲蓬头 Ø 300 mm。

Chrome

Black to White

Brushed

Matt Luxe

Matt Golden



Ø 300 162 8 L/min 24 L/min

Shower heads

FINITURA • FINISHING • FARBE • COULEUR • ACABADO •
 ОТДЕЛКА • 表面处理

04.2324.0

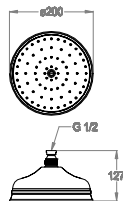

- Soffione doccia Ø 200 mm.
- Shower head Ø 200 mm.
- Kopfbrause ø 200 mm.
- Douche de tête ø 200 mm.
- Rociador ø 200 mm.
- Душевая лейка ø 200 мм.
- 莲蓬头 ø 200 mm.

Chrome

Black to White

Brushed

Matt Luxe

Golden

Matt Golden



ø 200

72

7 L/min

20 L/min

A

04.2327.0

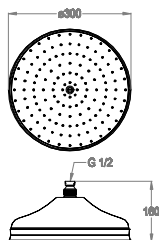

- Soffione doccia Ø 300 mm.
- Shower head Ø 300 mm.
- Kopfbrause ø 300 mm.
- Douche de tête ø 300 mm.
- Rociador ø 300 mm.
- Душевая лейка ø 300 мм.
- 莲蓬头 ø 300 mm.

Chrome

Black to White

Brushed

Matt Luxe

Golden

Matt Golden



ø 300

136

8 L/min

20 L/min

A